

中央空调工程设计常见问题

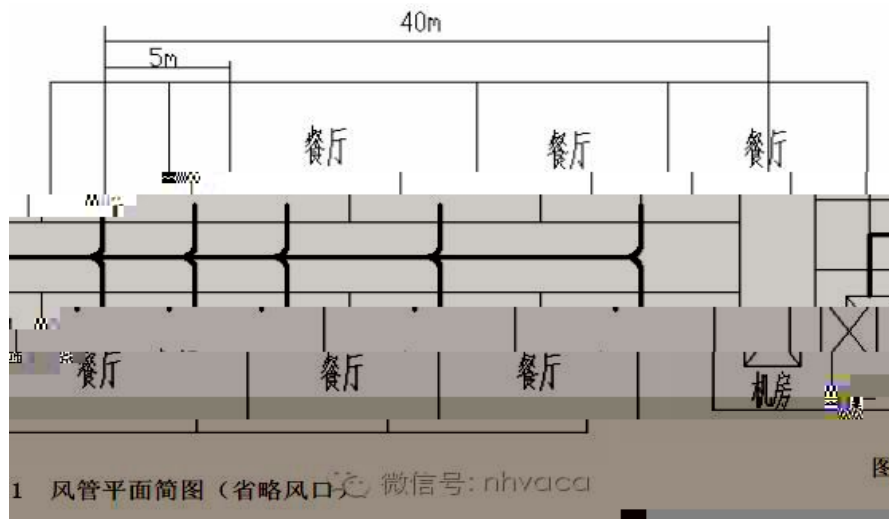



图 2 吊顶回风筒结构



图 1-1-1 三相系统故障示意图

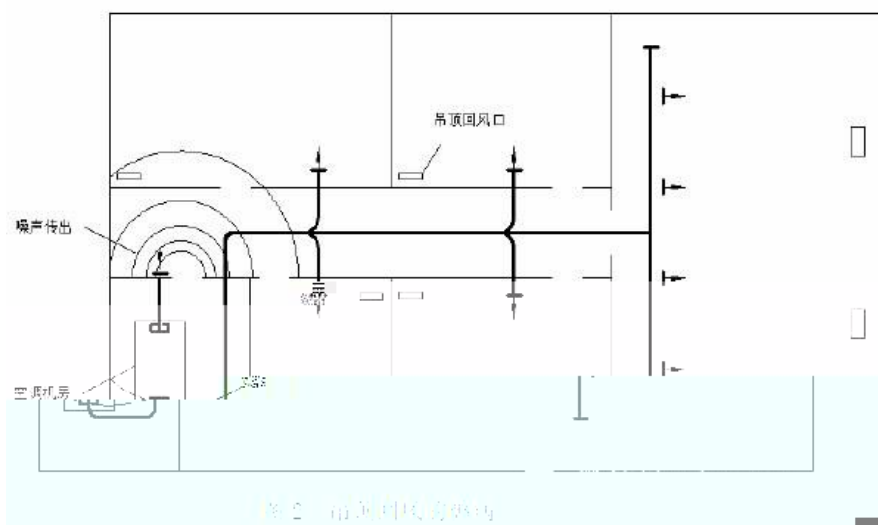

图 4 中间二次换热分区图 微信号: nhvac

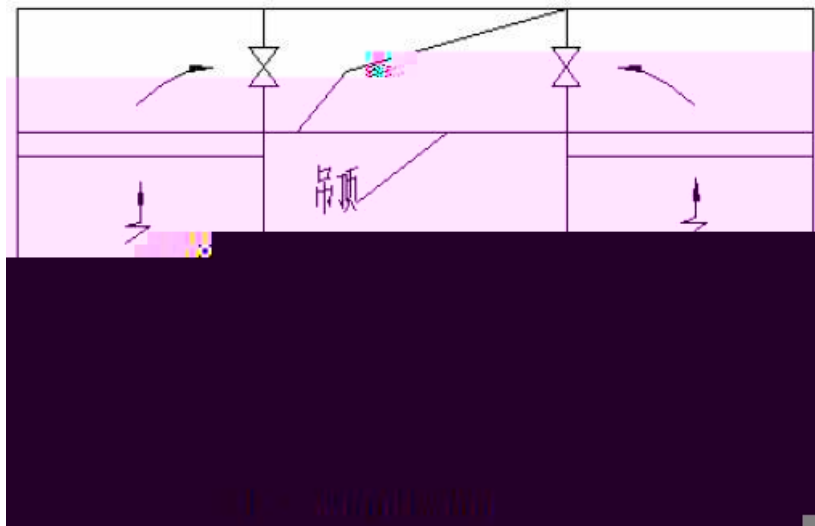

图 5 上下分别设置冷源示意图 微信号: nhvacd

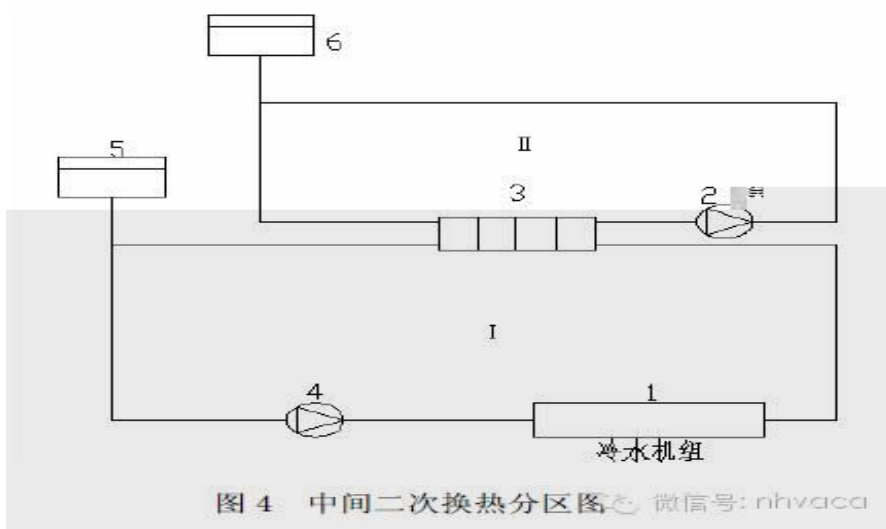

图 6 分设冷源分区示意图 微信号: nhvacd



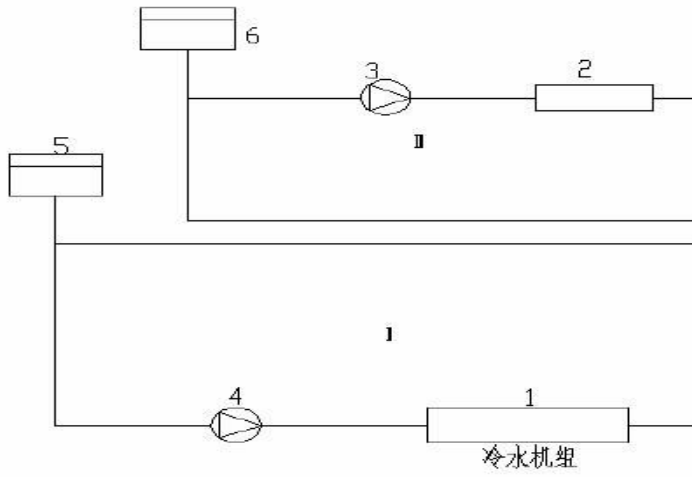

图 1

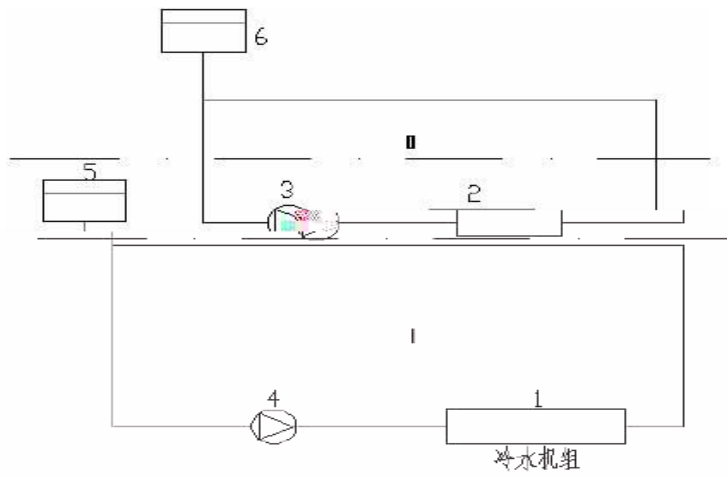
对墙壁的高度没有限制



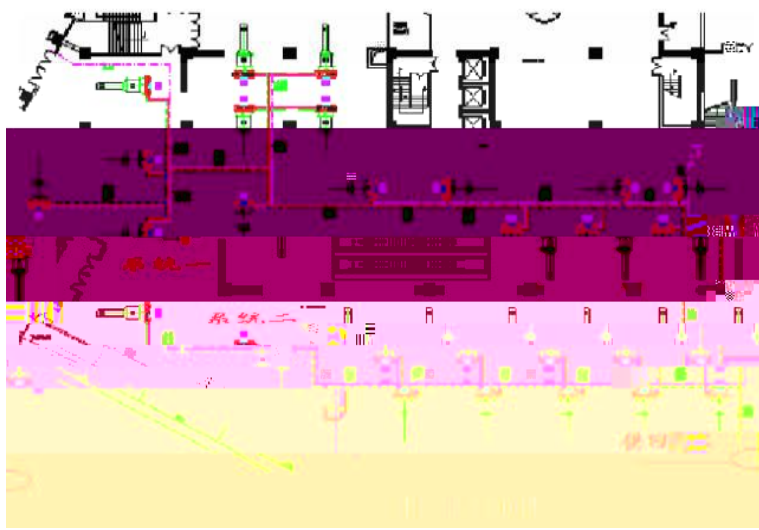
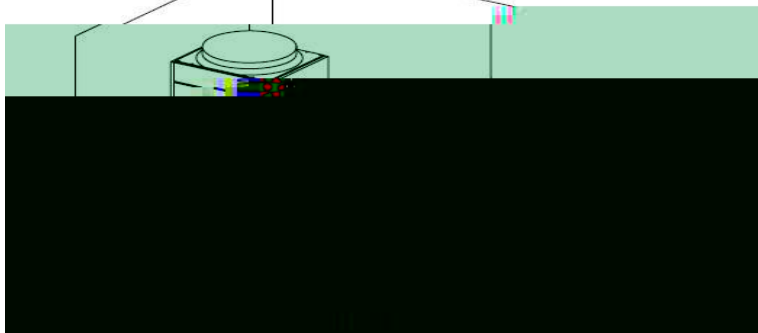
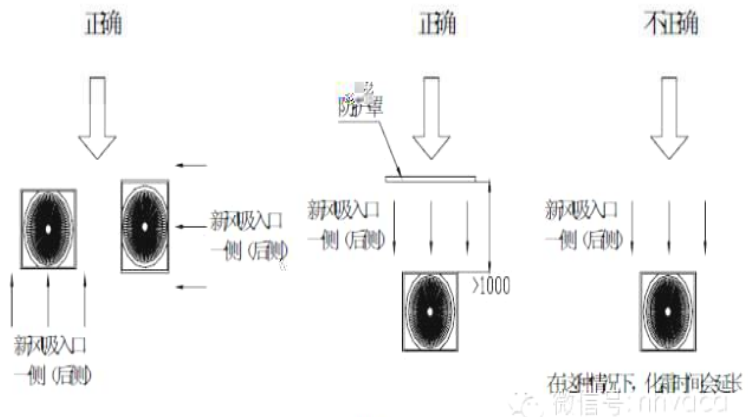

图 3

